

# ETC Quick Guide

## Source Four LED Series 3

### Overview

Use the images below as a guide to connect power and data and to navigate the basic features of the fixture. For complete information, download the *Source Four LED Series 3 User Manual* at [etcconnect.com](http://etcconnect.com), or view online help on your smartphone or tablet by scanning this code.

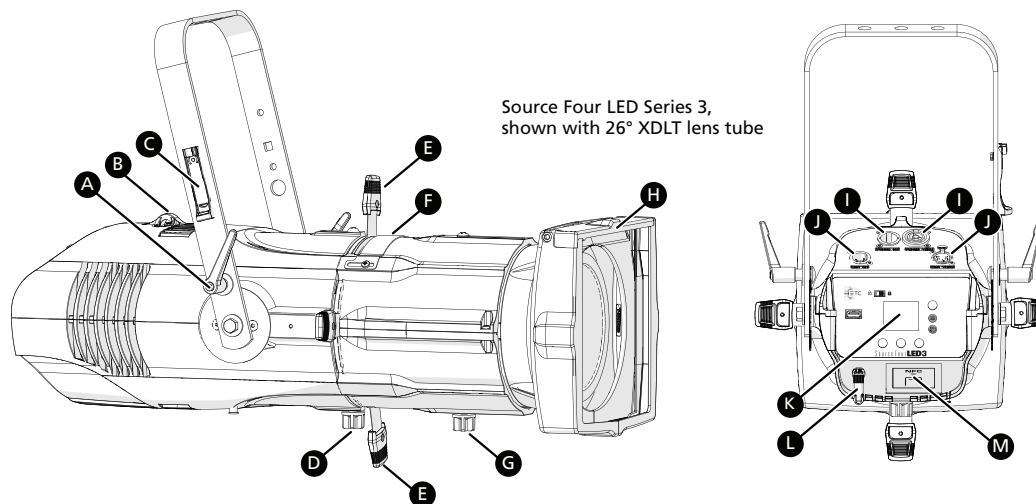

A	<b>Yoke tilt-lock:</b> Tilt the fixture as needed, and then turn the tilt-lock clockwise to lock the position. If necessary, pull the tilt-lock away from the stem to adjust the tilt-lock position.
B	<b>Safety cable attachment point:</b> Attach safety cable to the fixture housing.
C	<b>Antenna storage accessory:</b> When transporting or storing the fixture, store the wireless antenna on the yoke to protect it.
D	<b>Barrel rotation knob:</b> Loosen to rotate the barrel, and then tighten to secure it.
E	<b>Shutters:</b> Use four framing shutters to shape the beam.
F	<b>Pattern holder slot and accessory slot:</b> Insert an A-size, B-size, or glass pattern holder, and insert an accessory, such as a drop-in iris or motorized pattern device.
G	<b>Beam focus knob:</b> Loosen to adjust the lens tube position, and then tighten to secure it ( <a href="#">page 5</a> ).
H	<b>Accessory holder:</b> Insert a color frame or other accessory, and then lock the holder.
I	<b>Power In and Power Thru connectors:</b> powerCON® TRUE1 TOP connectors for power in and power thru ( <a href="#">page 5</a> ).
J	<b>DMX In and DMX Thru connectors:</b> Five-pin XLR connectors for DMX/RDM in and thru.
K	<b>User interface:</b> View the fixture status, set the DMX address and mode, or set stand-alone options.
L	<b>Antenna:</b> For use when controlling the fixture using wireless DMX. The fixture ships with the antenna stored in the antenna storage accessory (C). Install before using the fixture ( <a href="#">page 4</a> ).
M	<b>NFC (Near Field Communication) tag:</b> Use the Set Light app to wirelessly configure the fixture, with or without power applied to the fixture.



# ETC Quick Guide

## Source Four LED Series 3

### User Interface

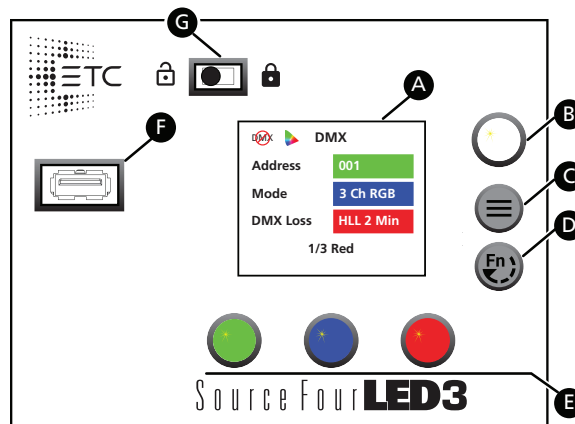

A	<p><b>Display:</b> The colors of options on the display correspond to the colors of the encoders below the display (E) and the Intensity encoder to the right of the display (B).</p>
B	<p><b>Intensity encoder:</b></p> <ul style="list-style-type: none"> <li>• When in DMX mode, press the Intensity encoder to enter Focus mode when focusing the fixture.</li> <li>• When configuring the fixture in one of the stand-alone modes, press the Intensity encoder to toggle between the current intensity and 0, or turn the Intensity encoder to modify the white fields on the display. See <a href="#">Use Fixture in Stand-alone Mode on page 6</a>.</li> <li>• When navigating from the <b>Main Menu</b> screen, turn the Intensity encoder to scroll through menu options, and then press the Intensity encoder to select a menu option.</li> </ul>
C	<p><b>Menu button:</b> Press to view the <b>Main Menu</b> screen and configure the fixture. Press the button again to return to the previous screen when you are setting configuration options.</p>
D	<p><b>Function button:</b> Press the button, use the Intensity encoder to navigate to one of the following modes, and then press the Intensity encoder to select it:</p> <ul style="list-style-type: none"> <li>• <b>DMX:</b> View and set DMX parameters for the fixture.</li> <li>• <b>Studio:</b> Use one of three studio (white light) presets, or customize the presets.</li> <li>• <b>Color:</b> Use one of 12 color presets, or customize the presets.</li> <li>• <b>Effects:</b> Use a sequence, or customize a sequence.</li> <li>• <b>Preset:</b> Use one of 12 presets (color preset + fade time), or customize the presets.</li> </ul> <p>See <a href="#">Use Fixture in Stand-alone Mode on page 6</a> and <a href="#">Use Fixture in DMX Mode on page 6</a>.</p>
E	<p><b>Encoders (Red, Green, Blue):</b> The colors of encoders correspond to options on the display. Press to activate the options at the bottom of the display, or turn to modify the values on the display.</p>
F	<p><b>USB port:</b> Use for updating firmware, saving and loading fixture configuration settings, or saving error logs via a flash drive.</p>
G	<p><b>UI lock:</b> Set this switch to lock the UI. This prevents inadvertent changes to the UI.</p>

# ETC Quick Guide

## Source Four LED Series 3

---

### Safety

---



**WARNING: RISK OF ELECTRIC SHOCK!** The light source in this luminaire is not user-replaceable, and must be replaced only by a qualified technician. Contact ETC Customer Support for assistance.

**AVERTISSEMENT : RISQUE DE DÉCHARGE ÉLECTRIQUE!** La source lumineuse de ce projecteur n'est pas remplaçable par l'utilisateur et ne doit être remplacée seulement par un technicien qualifié. Contactez le service client ETC pour obtenir de l'assistance.

---



**WARNING:** Note the following safety warnings before use:

- Use the fixture in dry locations only, where humidity does not exceed 90 percent (non-condensing).
  - Connect the fixture to a non-dimmable power source in order to avoid damage to the fixture's internal power supply and other electrical components. Using a dimmable power source can damage the fixture and will void the warranty.
  - This product must be installed in accordance with the applicable installation code by a person familiar with the construction and operation of the product and the hazards involved.
  - Disconnect the fixture from power and DMX and allow it to cool before installing accessories or performing any cleaning and maintenance.
  - Only use mounting hardware that is rated for the total weight of the fixture and accessories.
  - In addition to primary suspension, attach a safety cable (or other approved safety device) to the fixture. Safety cables must be rated to support ten times the fixture weight. Consult local standards to ensure that safety cables meet all requirements.
  - Check that the accessory holder is locked and that any accessory safety cables are connected before mounting the fixture.
  - When adjusting the fixture tilt, be aware that a lens tube adds weight to the front of the fixture. Use caution to control unintended fixture movement when adjusting the fixture tilt.
  - Risk of eye injury. Do not stare directly into the light.
  - Do not operate the fixture without the lens installed.
  - Do not use this fixture with a damaged power lead. If the power lead (cord set) is damaged, it must be replaced.
  - Do not use this fixture if the lens is deeply scratched or cracked. You must replace the lens when it is damaged.
-





# ETC Quick Guide

## Source Four LED Series 3

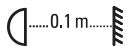

**AVERTISSEMENT** : Prendre connaissance des avertissements de sécurité suivants avant toute utilisation :

- Ce produit doit être installé selon le code d'installation pertinent, par une personne qui connaît bien le produit et son fonctionnement ainsi que les risques inhérents.
- Débranchez le projecteur de son alimentation et du DMX et laissez-le refroidir avant d'installer des accessoires ou d'effectuer un nettoyage ou un entretien.
- N'utilisez que de la quincaillerie de montage adaptée au poids total des projecteurs et des accessoires.
- En plus de la suspension principale, fixez une chaîne de sécurité (ou tout autre dispositif de sécurité homologué) au projecteur. Les chaînes de sécurité doivent être en mesure de supporter dix fois le poids du projecteur. Consultez les normes locales pour vous assurer que les câbles de sécurité respectent toutes les exigences.
- Vérifiez que le porte-accessoires est verrouillé et que les élingues de tous les accessoires sont bien attachées avant de monter le projecteur.
- Lorsque vous ajustez l'inclinaison de l'appareil, sachez que le nez optique ajoute du poids à l'avant de l'appareil. Soyez prudent afin de contrôler des mouvements involontaires du luminaire lors du réglage de son inclinaison.
- Risque de lésion oculaire. Ne fixez pas directement la lumière.
- N'utilisez pas le projecteur sans que la lentille soit installée.
- Ne pas utiliser ce projecteur avec un cordon d'alimentation endommagé. Si le cordon d'alimentation (câble) est abîmé, il doit être remplacé.
- N'utilisez pas ce projecteur si la lentille présente des rayures ou des fissures profondes. Il faut remplacer la lentille si elle est abîmée.

	The luminaire must be installed at least 0.1 m (4.0 in) away from all lighted objects.	Le luminaire doit être installé à au moins 0,1 m (4,0 po) de tout objet éclairé.
	Do not mount the fixture on or near a flammable surface.	Ne pas installer le projecteur sur ou à côté d'une surface inflammable.
	Do not stare at the operating light source.	Ne pas regarder la source de lumière lorsqu'elle fonctionne.
	This product should not be discarded as unsorted waste but must be sent to separate collection facilities for recovery and recycling.	Ce produit ne doit pas être jeté avec les déchets ménagers mais doit être déposé dans une collecte de déchets électroniques ou dans un point de collecte.

## Install the Antenna

The fixture ships with the antenna stored in the antenna storage accessory (see image on [page 1](#)). If you will use wireless control, install the antenna before using the fixture.

1. Grasp the antenna at the top and pull outward to unsnap it from the antenna storage accessory.
2. Locate the antenna base next to the NFC tag on the back of the fixture (see image on [page 1](#)). Insert and twist the antenna to screw it into the base.

## Install a Shutter Barrel

You can use either an XDLT shutter barrel or a legacy Source Four shutter barrel. (For legacy Source Four shutter barrels, you must use the legacy Source Four lens tubes, too.)

Insert the shutter barrel into the light engine, and rotate clockwise 45 degrees. Secure with the provided screw and barrel rotation knob.

# ETC Quick Guide

## Source Four LED Series 3

---

### Install a Lens Tube

You can use either XDLT lens tubes or legacy Source Four lens tubes. (For legacy Source Four lens tubes, you must use the legacy Source Four shutter barrel, too.) For guidance on selecting lens tubes for maximum output and highest quality imaging, see the Source Four LED Series 3 datasheet at [etcconnect.com](http://etcconnect.com).

Slide the lens tube into the shutter barrel, and secure with the provided screw and beam focus knob.

### Connect Power and Data

1. Attach 5-pin XLR cable to the DMX In connector if you are using external control.
2. Plug the XLR cable (if using) into the DMX source or data daisy-chain.
3. Use the Power Thru and DMX Thru connectors to connect other fixtures using the following guidelines:
  - Link up to 5 fixtures via Power Thru connector when used with R20 Relay Module, ER15 Relay Module, or Unison Echo Relay Panel (consult breaker-trip curves when used with other equipment). When linking fixtures, do not exceed the rating of the power connectors (20 A in 120 V/60 Hz regions and 16 A in 240 V/50 Hz regions).
  - Link up to 32 device loads on the DMX daisy chain.
4. Supply power to the fixture by attaching the power cable to the Power In connector, and then plugging the power cable into AC power (100–240 VAC, 50/60 Hz) on a non-dimmable circuit.

### Focus the Fixture

1. Apply power to the fixture, and wait until the fixture has booted up (the ETC splash screen displays during boot up).
2. Press any encoder to "wake" the display.
3. What screen is currently displayed?
  - **DMX:** Press any encoder to leave the view-only screen, and then press the Intensity encoder to turn on the LED array. The display shows a timeout countdown to indicate how long the LED array will remain on at 100% intensity. You can turn the Intensity encoder to reset the timeout countdown to 5 minutes.
  - **All other screens (Studio, Preset, etc.):** Press the Intensity encoder to turn on the LED array, and turn the Intensity encoder to adjust the intensity.



**WARNING:** When adjusting the fixture tilt, be aware that a lens tube adds weight to the front of the fixture. Use caution to control unintended fixture movement when adjusting the fixture tilt.

**AVERTISSEMENT :** Lorsque vous ajustez l'inclinaison de l'appareil, sachez que le nez optique ajoute du poids à l'avant de l'appareil. Soyez prudent afin de contrôler des mouvements involontaires du luminaire lors du réglage de son inclinaison.

---

4. Adjust the fixture to the desired position:
  - a. Loosen the yoke tilt-locks, tilt the fixture as needed, and then tighten the tilt-locks.
  - b. Loosen the beam focus knob, adjust the lens tube position as needed, and then tighten the knob.
5. Press the Intensity encoder to turn off the LED array.

# ETC Quick Guide

## Source Four LED Series 3

### Use Fixture in DMX Mode

After you connect power and data to the fixture and provide DMX, press the **Function** button (Ⓜ), use the Intensity encoder to navigate to **DMX Mode**, and then press the Intensity encoder to select it. In the **DMX** screen, you can set the DMX address, DMX mode, and DMX loss behavior.

The **DMX** screen displays the current DMX values. Press any of the encoders to "wake" the display, and then press any of the encoders to edit the values. The colors of the encoders correspond to options on the display. Turn an encoder to modify the corresponding value, and then press the encoder to save all values on the screen.

### DMX Modes

	Direct (Daylight HDR)	Direct (Lustr X8)	Expanded	Studio	3 Ch RGB	1 Channel
RDM Personality ID ▶	1	1	2	3	4	5
DMX Channel ▼						
1	Intensity	Intensity	Intensity	Intensity	Red	Intensity
2	Deep Red	Deep Red	CCT	CCT	Green	
3	Red	Red	Tint	Tint	Blue	
4	Mint	Amber	Tuning	Tuning		
5	Cyan	Lime	Mix	Strobe		
6	Blue	Green	Red	Curve		
7	Indigo	Cyan	Green	Fan		
8	Strobe	Blue	Blue			
9	Curve	Indigo	Strobe			
10	Fan	Strobe	Curve			
11		Curve	Fan			
12		Fan				

For complete DMX channel information, scan the QR code on the first page or visit [etconnect.com](http://etconnect.com) to view the full *Source Four LED Series 3 User Manual*.

### Use Fixture in Stand-alone Mode

After you connect power to the fixture, press the **Function** button (Ⓜ), use the Intensity encoder to navigate to one of the following stand-alone modes, and then press the Intensity encoder to select it:

- **Studio:** Use one of three studio (white light) presets, or customize the presets.
- **Color:** Use one of 12 color presets, or customize the presets.
- **Effects:** Use a sequence, or customize a sequence.
- **Preset:** Use one of 12 presets (color preset + fade time), or customize the presets.

The colors of options on the display correspond to the colors of the encoders below the display and the Intensity encoder to the right of the display. Turn an encoder to modify the corresponding value on the display, or press an encoder to activate the corresponding option at the bottom of the display. Press the Intensity encoder to toggle between the current intensity and 0%.

If the fixture is connected to other Source Four LED Series 3 fixtures that are in the same stand-alone mode, the connected fixtures will play the same preset or effect.

# ETC Quick Guide

## Source Four LED Series 3

### Select a Color Temperature

1. Press the **Function** button (⊕), use the Intensity encoder to navigate to **Studio Mode**, and then press the Intensity encoder to select it.
2. Press the color encoder that matches the studio preset you want to use (Blue = 3200 K, Green= 4500 K, Red= 5600 K).

#### More Options

- **Turn off** the preset: Press the Intensity encoder to toggle the intensity value from the current value to 0. Press the Intensity encoder again to toggle back to the previous intensity value.
- **Modify** the preset: Turn the encoders to change the corresponding values. For example, turn the Intensity encoder to change the intensity value, or turn the blue encoder to change the color temperature value.
- Modify the **intensity**: Turn the Intensity encoder to adjust the intensity, or press and turn the Intensity encoder to adjust the intensity by 1/4 stop.
- Modify the **tuning**: Press and turn the red encoder to change the value to **Metamer**, and then turn the red encoder to change the **Tune** value (the "recipe" of the metamer). Press and turn the red encoder again to return to the **Brightest** or **Spectral** options.
- **Revert** to the original preset: Press the encoder that corresponds to the preset again to restore the original values.
- **Save** the modified preset: Press and hold the encoder that corresponds to the preset that you want to re-record. The display shows a three-second countdown before re-recording the preset.

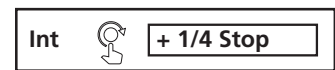

### Select a Color

1. Press the **Function** button (⊕), use the Intensity encoder to navigate to **Color Mode**, and then press the Intensity encoder to select it.
2. Turn the encoders to change the corresponding values. For example, turn the Intensity encoder to change the intensity value, or turn the green encoder to change the hue value. The crosshairs on the display indicate the approximate color.

You can use a preset as a starting point for a color by pressing the color encoder that matches the preset. Turn the red encoder to move to another page of presets.

#### More Options

- **Turn off** the color: Press the Intensity encoder to toggle the intensity value from the current value to 0. Press the Intensity encoder again to toggle back to the previous intensity value.
- **Revert** to the original color of a preset: Press the encoder that corresponds to the preset again to restore the original values.
- **Save** the color to a preset: Press and hold the encoder that corresponds to the preset that you want to re-record. The display shows a three-second countdown before re-recording the preset. Changes that you make to presets in the **Color** screen also affect presets in the **Effects** screen and the **Preset** screen.
- **Change** the color selection mode: Press the red encoder (for the **Settings** icon ⚙️) to change between **Hue/Saturation** (default color selection mode) and **x,y**. In **x,y** mode, you set the **x** and **y** coordinates within the CIE 1931 chromaticity diagram. (See image at right.)

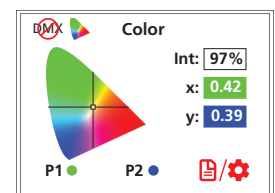

# ETC Quick Guide

## Source Four LED Series 3

---

### Select a Preset

1. Press the **Function** button (⊕), use the Intensity encoder to navigate to **Preset Mode**, and then press the Intensity encoder to select it.
2. Turn the green encoder to select a preset, and then press the encoder to play the preset.

### More Options

- **Pause** the preset fade: Press the green encoder to toggle between play and pause.
- **Stop** the preset: Press the red encoder.
- **Modify** the preset: Turn the Intensity encoder to change the intensity, or turn the red encoder to change the fade value.
- **Capture** the current DMX look: Press and hold the blue encoder (for the **Snapshot** icon 📷). The display shows a 3-second countdown before re-recording the preset. Capture is limited to three DMX modes: **3 Ch RGB**, **Studio**, and **Expanded**.
- **Modify** the preset **color**: Press the blue encoder (for the **Edit** icon ✎). In the **Edit Preset Color** screen, turn the encoders to change the corresponding values. The crosshairs on the display indicate the approximate color. Press the green encoder (for the **Save** icon 💾) to save the new color to the preset.
- **Push** the preset to connected fixtures: Press the **Menu** button (⊖), and then use the Intensity encoder to navigate through the menu: **Local Settings > Push Presets**. When the screen prompts you to confirm, press the green encoder (for the **OK** icon ✓) to continue.

## Configure Fixtures Wirelessly Using the Set Light App

Download the Set Light app to a smartphone with NFC functionality, use the app to set fixture parameters, and then tap the smartphone to the NFC tag on the fixture to configure it wirelessly—even when the fixture is not powered on. Or, after you configure the Multiverse settings on the fixture, use the Set Light app to configure one fixture or multiple fixtures wirelessly from a smartphone or tablet. Visit [etcconnect.com/Apps](http://etcconnect.com/Apps) or scan the code for more information about the Set Light app.



Set Light app